

MASTERGRAIN™

REDEFINE YOUR DOOR



CREATE A FIRST IMPRESSION THAT'S BUILT TO LAST

Redefine Your Door

In 2008 Weber Manufacturing Technologies Inc., a Midland, Ontario, Canada based tooling company, set out to leverage their proprietary Nickel Vapor Deposition (NVD) technology to completely revolutionize how fiberglass entry doors are made. NVD technology provides a unique way to capture fine, surface grain details, found on wood, leather and other materials.

NVD technology works by taking a silicone cast of the actual material and then creating highly specialized nickel tools, which are used to transfer the grain. With NVD, Weber created a complete offering of fiberglass door designs and fiberglass clad components. The offering was branded MASTERGRAIN™ and the company began selling doors across North America. There are other technologies which can replicate woodgrain for fiberglass door production, but none can deliver the intricate and beautiful detail that a MASTERGRAIN door is able to produce at a microscopic level using NVD technology. Today, in addition to MASTERGRAIN doors, Weber uses NVD technology to create tooling and finished products for some of the world's most luxurious automotive, aerospace and building products brands.

YourStyle™ Edge Smooth | E831 | Distance





Esperanza | Contemporary Cherry Stainless Inlay | C614 | Cigar

BUILT BETTER BECAUSE BEAUTY IS ONLY SKIN DEEP



Rustic Knotty Alder | KA159 | Cashew



Thomas | Contemporary Edge Smooth Engraved | E953 | Naval

MASTERGRAIN™ products can replicate, with fine detail, woodgrain and texture right down to the knots and swirls that give a wood door its unique character and charm. Components come together seamlessly to create luxurious, durable, high-quality doors that distinguish a home's exterior from a distance and completely adorn its interior. Going beyond its striking appearance, you will find a MASTERGRAIN door has robust build quality that delivers energy and performance criteria that is best-in-class in the door industry.

The difference is found in the design and engineering, in the quality of the materials used and finally in the state-of-the-art manufacturing process. MASTERGRAIN is the only door brand in the industry to offer fiberglass cladded components to improve both appearance and performance. Door skins are made thicker than industry standard to provide more strength to better resist dents, dings and scratches. In addition, composite materials are used for many of the door slab and frame components to eliminate twisting, warping, mold and rot.

The high-density polyurethane foam core provides best-in-class insulation and is CFC free. There is more to a MASTERGRAIN door than meets the eye, although what meets the eye is extremely beautiful. Explore this brochure to find out which MASTERGRAIN door is right for you.

CONTENTS

A True Entry Door Solution	05	Fir Craftsman	30 - 31
It's What's Inside That Counts	06	Edge Smooth Contemporary	35 - 37
Molded Fiberglass Door Lite Frames	07	Edge Smooth YourStyle™	38 - 39
Composite Components	08	Edge Smooth Craftsman	40
Fiberglass Cladded Astragals	09	Edge Smooth Shaker	41
Transom Sill, Mull Casing & Glass Stop	09	Edge Smooth Contemporary Stainless Inlay	42
Cherry Contemporary Engraved	13	Edge Smooth Contemporary Engraved	43
Cherry Contemporary Stainless Inlay	15	Mahogany Classic	47 - 49
Cherry Classic	17 - 21	Oak Classic	53 - 57
Cherry Rustic	22 - 23	Knotty Alder Rustic	60 - 61
Fir YourStyle™	27 - 29	Dimension Matrix	62 - 67



A TRUE ENTRY DOOR SOLUTION

What sets MASTERGRAIN™ apart? It's the commitment to quality and investment in world-class manufacturing technologies. Every MASTERGRAIN door is built with fiberglass-clad components in order to deliver a finish that is seamless, strong, and, perhaps best of all, completely stainable. The result is a versatile door that flawlessly replicates the look, texture and aesthetic of real wood.

- 1. Door Skins**
Nickel Vapor Deposition (NVD) technology, a process exclusive to MASTERGRAIN, is used to mold the world's strongest fiberglass door skins of various thicknesses and finishes.
- 2. Polyurethane Foam Core**
High-density, CFC-free polyurethane foam is injected into the slab core to offer superior insulation, energy efficiency, sound-dampening, and resistance to dents and other damage.
- 3. Engineered Wood with Hardwood Maple Cap**
Stiles are made from premium materials so they are exceptionally strong, stable and straight. They are also built wider than industry standard with uniform lock and hinge sides to accommodate almost any hardware and improve door performance over time.
- 4. Composite Rails**
Rot-resistant composite (plastic film and wood fibers) are used for both the top and bottom rails. This material is resilient and more stable than wood or other materials.
- 5. Composite Reinforced Mull Post**
Composite core components with aluminum-reinforcement offers increased security, strength and fire ratings. Plus, fiberglass cladding adds complete design versatility.
- 6. Mill Finish Aluminum Sills**
Designed specifically to provide a tight seal, aluminum sills protect against moisture, air and debris infiltration into the home while offering the ability to complement any entry door system and configuration.
- 7. Molded Fiberglass Door Lite Frame**
A patented clip assembly system is employed to eliminate the need for unsightly screws and plugs. It creates a unique look that is completely seamless.
- 8. Simulated Dividing Lites (SDLs)**
Made with molded fiberglass to provide countless customization options, SDLs can be used in any design configuration as well as stained to match door panels and other components.
- 9. Sidelite Composite Glass Stop**
Matching composite glass stops, made with or without woodgrain, are installed on the inside of the door lite frame to hold glass securely in place, deliver improved performance and durability and make removal/replacement easier.



- 10. Composite Jambs with Woodgrain Fiberglass Cladding**
All jambs are made using composite material. Woodgrain fiberglass-clad jambs are offered to attain a completely seamless look as they can be stained.
- 11. Brickmold with Woodgrain Fiberglass Cladding**
Available in a variety of sizes and finishes, this fiberglass-clad brickmold is used as an aesthetic casing. It will not rot, split or warp and is completely stainable for a beautiful and seamless aesthetic.

IT'S WHAT'S INSIDE THAT COUNTS

Every MASTERGRAIN™ door is engineered and built in North America by skilled technicians to ensure the highest quality. Unlike other doors, the manufacturing processes and technologies which MASTERGRAIN employs, eliminate the need to compromise between strength and lasting beauty.

- Does NOT warp, rot or crack like wood doors and requires less maintenance
- Does NOT rust or dent like steel doors
- Excellent grain and stain matching across fiberglass components
- Engineered for the extreme hot and cold temperatures of North America

STRENGTH

A pair of robust 4-¹/₁₆" stiles run down each side of the door slab. The stiles are made of 3-⁷/₁₆" engineered wood and a ⁵/₈" hardwood cap.

HIGH DEFINITION

To produce the highest definition woodgrain fiberglass doors, it starts with high quality hand picked real wood that is transformed into a mold using our industry leading NVD Technology. Our skins have a minimum thickness of 0.09" to 0.175" to accommodate inlays and routed designs.

PERFORMANCE

All of our doors are insulated with high density, CFC free, polyurethane foam. Our formula improves energy efficiency and sound abatement.

CONSTRUCTION

Doors are constructed using rot resistant composite top and bottom rails.

IMPACT TESTED PRODUCTS ARE FOUND UNDER THE FOLLOWING APPROVAL NUMBERS

Non-Impact	Impact	HVHZ
#FL13320	#FL21852	#FL21852.19*

Visit www.floridabuilding.org/pr/pr_app_srch.aspx for details.

*Tested with opaque 3/0 x 8/0 outswing.

* MASTERGRAIN doors are NAFS Certified.

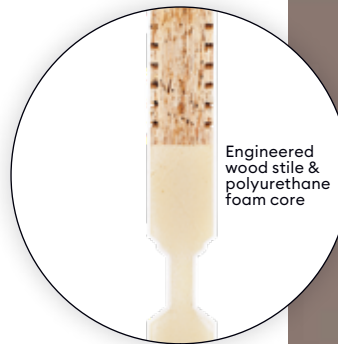

Engineered wood stile & polyurethane foam core



Sharp distinctive embossment deep definition

Smooth fiberglass skin with brush stroke finish

Skin thickness is 0.090" (certain styles available in 0.175" for engraving & inlays)

Engineered wood stiles with hardwood maple edge cap 4-¹/₁₆" both sides full length



Kerf notched top and bottom wood-plastic composite (WPC) rail

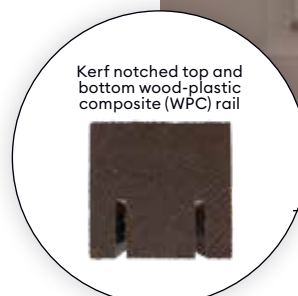

MOLDED FIBERGLASS DOOR LITE FRAMES & SIMULATED DIVIDING LITES (SDLs)

MASTERGRAIN™ molds their own patented woodgrain and smooth fiberglass door lite frames that use a clip assembly system that eliminates the need for unsightly screws and plugs to deliver a unique uninterrupted look. MASTERGRAIN also offers molded fiberglass simulated divided lites (SDLs).

- Fiberglass frames are more rigid than plastic frames.
- No welded corners ensures a tight weather seal to the door and minimizes distortion.
- Plugless frame system eliminates all unsightly screw holes and plugs for a clean aesthetic.
- Traditional plugged door lite system uses screws and plugs to deliver certified performance for impact, air, water and cycle testing.
- Molded fiberglass SDL bars provide an energy-efficient way to create a number of design configurations for a completely custom look.
- Door lite frames and SDLs can be stained to match door panels and all other MASTERGRAIN door components for a seamless beautiful aesthetic.

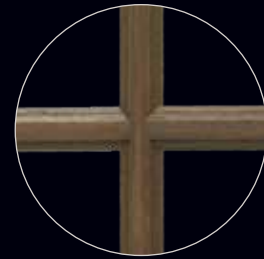

SDLs come pre-taped and notched to create a beautiful lap-joint



CONTEMPORARY SURROUND

Plugged or Plugless

Low profile



FLUSH SURROUND

Plugged or Plugless

Flush fit with optional integrated one piece dentil shelf



TRADITIONAL SURROUND

Plugged or Plugless

Raised profile



Plugged Frame System



Plugless Frame System

COMPOSITE COMPONENTS

The only NVD fiberglass cladded component frames available in the industry.



- Versatile lengths and widths
- 2X screw holding power due to rigid composite formulation and closed cellular structure
- Rot and moisture resistant
- Stronger than wood door frames
- Low maintenance
- Insect and rodent resistant

COMPOSITE JAMB

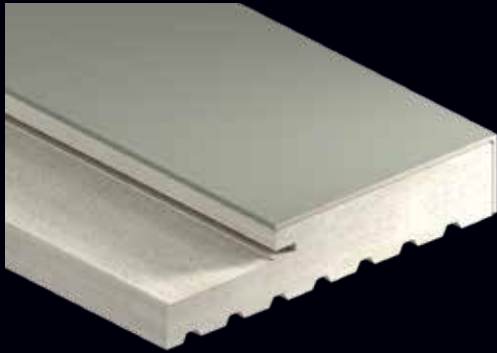

COMPOSITE JAMBS			
	4-9/16"	6-9/16"	7-5/8"
1-3/4" cladded	✓	✓	✗
1-3/4" non-cladded	✓	✓	✓

Size and availability depending on grain/model.



COMPOSITE BRICKMOLD

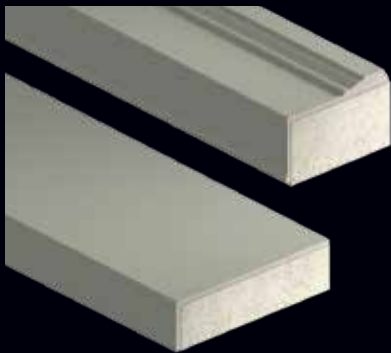

COMPOSITE CLADDDED BRICKMOLDS			
	Kontty Alder / Oak	Mahogany/Cherry	Fir
2"	✓	✓	✗
3-3/4"	✗	✓	✓

Size and availability depending on grain/model.

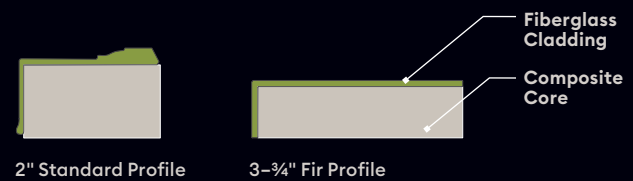

COMPOSITE MULL POST

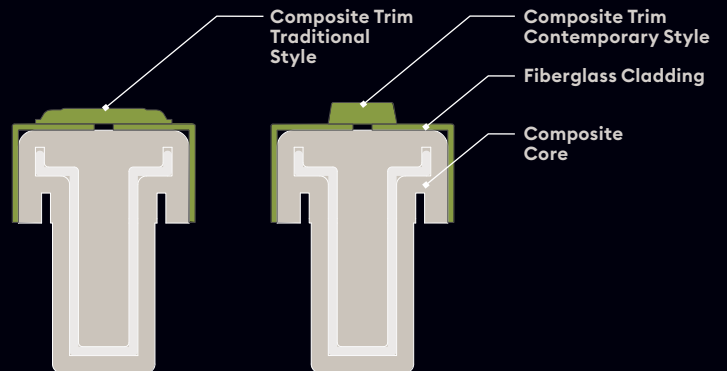

FIBERGLASS CLADDED ASTRAGALS

Aluminum astragal with fiberglass cladding to match door panels.

THERMALLY BROKEN

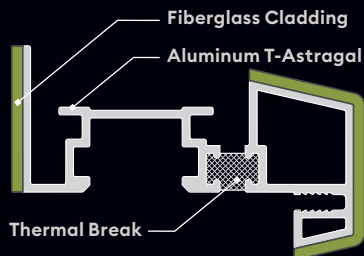

Cherry/Mahogany,
Knotty Alder/Oak and Fir

LH 6/8
RH 8/0

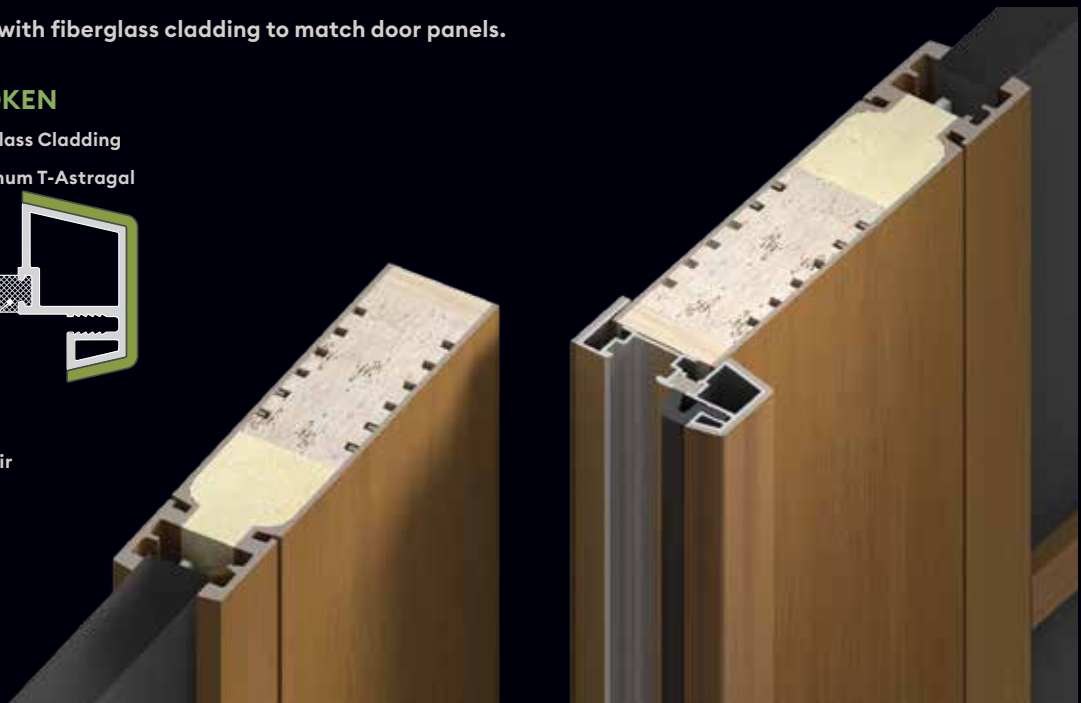

TRANSOM SILL, MULL CASING & GLASS STOP

COMPOSITE TRANSOM SILL WITH GRAIN



Size	Part #	Finish
5-5/8" x 120"	TSCOM4120	Grained
7-5/8" x 120"	TSCOM6120	Grained

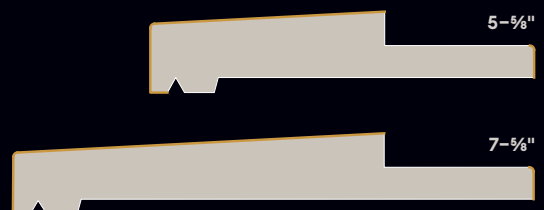

COMPOSITE GLASS STOPS



Size	Part #	Finish
3/4" x 1/2" x 144"	GS-COMG	Grained
3/4" x 1/2" x 144"	GS-COM	Smooth Raw
.354" x .553" x 99"	GSCOM99	Grained



CHERRY





Contemporary Cherry Engraved | C500 | Harvest



Solid Slabs Only



CHERRY

CONTEMPORARY ENGRAVED



C498**



C499* / C599*



C124** / C154**



C125** / C155**



C500 / C550



C501 / C551



C528 / C553



C536 / C552



C900 / C950



C901 / C951



C902 / C952



C903 / C953



C905 / C955

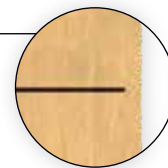

Engraving stops $\frac{3}{4}$ " from door edge for air and water protection

*Also available in 30" widths x 7' heights. Also available with 0.175" thick skins
 **Also available in 7' height. Also available with 0.175" thick skins

Custom design options are available.
 Subject to engineering review.

SIZING

Heights	6'-8"	8'		
Widths	32"	34"	36"	42"
Flush Sidelites Widths	10"	12"	14"	16"

2- $\frac{1}{4}$ " slab thickness available for 8' doors without glass.
 Only available for 36" x 8' and 42" x 8'

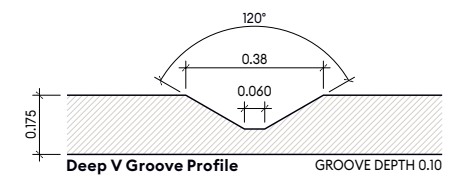
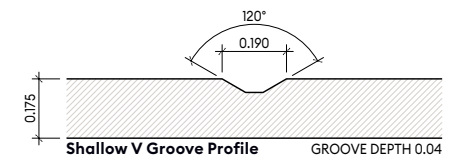
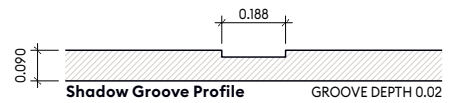

*Not engineering drawings, these are just for reference.



Solid Slabs Only



CHERRY

CONTEMPORARY STAINLESS INLAY



C601 / C608



C602 / C609



C603 / C610



C604 / C611



C605 / C612



C606 / C613



C607 / C614
*No custom sizes available

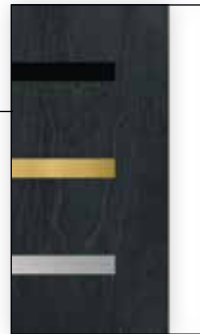

Inlays available in gold, black or stainless

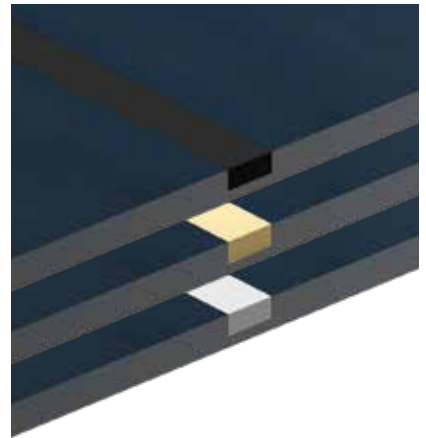

Custom design options are available.
Subject to engineering review.

SIZING

Heights

6'-8"

8'

Widths

34"

36"

42"

.175" skin thickness

2-1/4" slab thickness available for 8' doors without glass. Only available for 36" x 8' and 42" x 8'

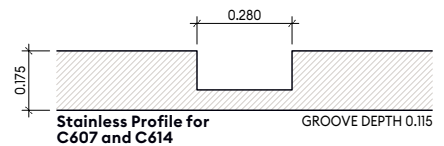
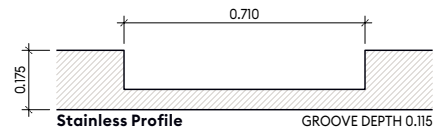

*Not engineering drawings, these are just for reference.

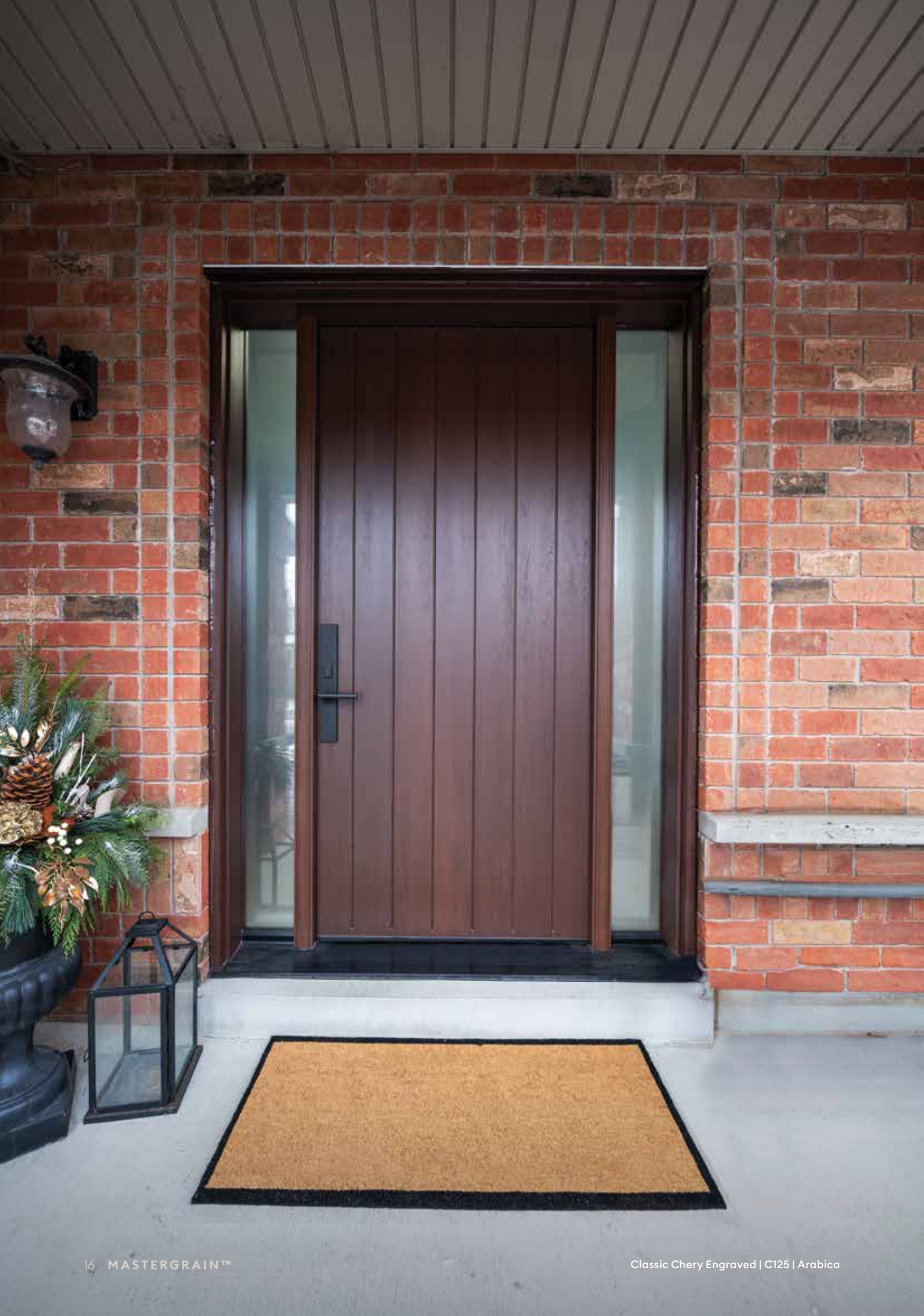

CHERRY

CLASSIC



C200
6 Panel



C201
22" x 64"



C206
22" x 64"



C207
22" x 64"



C208
22" x 64"



C209
22" x 64"



C210
22" x 64"



C-SL-36



C261*
6" x 64"



C202
8" x 64"



C267
8" x 64"



C268
8" x 64"



C269
8" x 64"



C270
8" x 64"



C271
8" x 64"



C272
8" x 64"



C211
8" x 64"

*Only available in 10"

SIZING

Heights

6'-8" 7'

Widths

32" 34" 36"

Sidelites Widths

10" 12" 14" 16"



Traditional Surround

CHERRY

CLASSIC



C205
22" x 11"



C221
22" x 11"



C215*
8 Panel



C216*
8" x 42"



C203
22" x 36"



C260
22" x 36"



C212
22" x 36"



C213
22" x 36"



C204
8" x 36"



C214
8" x 36"

SIZING

Heights

6'-8" 7'

Widths

32" 34" 36"

Sidelites Widths

12" 14" 16"

*8 panel doors only available in 34" and 36" widths.

10" Sidelites only available in flush



Traditional Surround



C220
3 Panel



C222
22" x 48"



C224
22" x 48"



C225
14" x 37"



C226
22" x 48"



C228
22" x 48"



C235
22" x 48"



C230
22" x 48"



C231
22" x 48"



C-SL-48



C223
8" x 48"



C227
8" x 48"



C229
8" x 48"



C243
8" x 48"



C262
8" x 48"



C232
8" x 48"

SIZING

Heights

6'-8" 7'

Widths

32" 34" 36"

Sidelites
Widths

12" 14" 16"

10" Sidelites only available in flush



Traditional Surround

CHERRY

CLASSIC



C233
2 Panel



C234
2 Panel



C236
22" x 48"



C238
22" x 48"



C239
14" x 37"



C240
22" x 48"



C242
22" x 48"



C263
22" x 48"



C244
22" x 48"



C245
22" x 48"



C-SL-48



C266*
6" x 64"



C227
8" x 48"



C229
8" x 48"



C243
8" x 48"



C262
8" x 48"



C232
8" x 48"

*Only available in 10"

SIZING

Heights

6'-8"

7'

Widths

32"

34"

36"

Sidelites Widths

10"

12"

14"

16"

10" Sidelites only available in flush



Traditional Surround



C250
2 Panel



C251
22" x 64"



C252
22" x 64"



C264
22" x 64"



C265
22" x 64"



C253
22" x 64"



C254
22" x 64"



C217*
2 Panel



C218*
2 Panel



C219*
2 Panel



SIZING

Heights

8'

Widths

32"

34"

36"

42"

Sidelites
Widths

10"

12"

14"

16"

2-1/4" slab thickness available for 36" x 8'
and 42" x 8' doors, without glass†

10" Sidelites only available in flush



C8-SL-48



C8-SL-64



C256
8" x 64"



C257**
8" x 48"



C258
8" x 64"



C259
8" x 64"

*Only available in 42"



Traditional Surround

CHERRY

RUSTIC



C100



C101



C103
14" x 37"



C104
22" x 48"



C110
22" x 37"



C113
22" x 37"



C118
22" x 37"



C102
22" x 48"



C107
22" x 48"



C109
22" x 48"



C153
22" x 48"



C112
22" x 48"



C114
22" x 48"



C-SLR-48



C106
8" x 64"



C105
8" x 48"



C108
8" x 48"



C161
8" x 48"



C111
8" x 48"



C119
8" x 48"



C115
8" x 48"

SIZING

Heights

6'-8"

7'

Widths

32"

34"

36"

Sidelites Widths

12"

14"

16"



Traditional Surround



C144



C145



C146
22" x 64"



C148
22" x 64"



C162
22" x 64"



C163
22" x 64"



C166
22" x 64"



C150
22" x 64"



C151
22" x 64"



C-SLR-64



C147
8" x 64"



C149
8" x 64"



C164
8" x 64"



C165
8" x 64"



C152
8" x 64"

SIZING

Heights

8'

Widths

32"

34"

36"

Sidelites
Widths

12"

14"

16"



Traditional Surround

FIR







FIR

YourStyle™



F800 / F801



F822 / F862



F823 / F863



F824 / F864



F825 / F865



F826 / F866



F827 / F867



F828 / F868



F829 / F869



F830 / F870



F831 / F871



F832 / F872

SIZING

Heights

6'-8"

7'

8'

Widths

34"

36"

SDL bars available in 3-½" and 5-½" widths.



F833 / F873



FIR

YourStyle™



F800-G / F801-G



F822-G / F862-G



F823-G / F863-G



F824-G / F864-G



F825-G / F865-G



F826-G / F866-G



F827-G / F867-G



F828-G / F868-G



F829-G / F869-G



F830-G / F870-G



F831-G / F871-G



F832-G / F872-G

SIZING

Heights

6'-8" 7' 8'

Widths

34" 36"

SDL bars available in 3-½" and 5-½" widths.



F833-G / F873-G



Flush Surround

FIR

CRAFTSMAN



F300 / F350



F302 / F351
23-3/4" x 15" / 23-3/4" x 19-1/4"



F303 / F352
23-3/4" x 15" / 23-3/4" x 19-1/4"



F304 / F353
23-3/4" x 15" / 23-3/4" x 19-1/4"



F305 / F354
23-3/4" x 15" / 23-3/4" x 19-1/4"



F306 / F355
23-3/4" x 15" / 23-3/4" x 19-1/4"

SIZING

Heights

6'-8" 7' 8'

Widths

34" 36"

Sidelites Widths

12" 14" 16"

Fir frames are flush fit. Integrated dentil shelf optional.



Integrated dentil shelf
option available



Flush Surround



F-SL2P / F380



F317 / F381
8" x 15" / 8" x 19-1/4"



F318 / F382
8" x 15" / 8" x 19-1/4"



F319 / F383
8" x 15" / 8" x 19-1/4"



F320 / F384
8" x 15" / 8" x 19-1/4"



F316 / F385
8" x 64" / 8" x 77"



F307 / F386
8" x 64" / 8" x 77"



F315 / F387
8" x 15" / 8" x 19-1/4"

EDGE SMOOTH







EDGE SMOOTH

CONTEMPORARY



E700 / E706

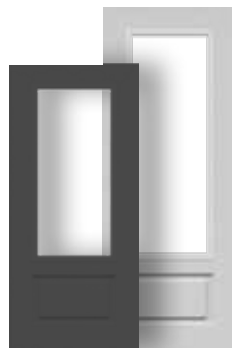

E715 / E620
22" x 48" / 22" x 64"

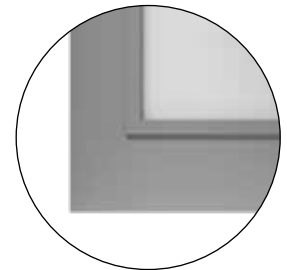

Contemporary Surround

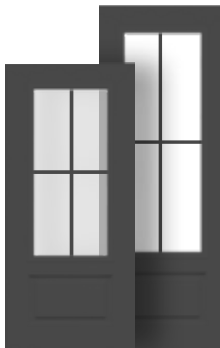

E673 / E773
22" x 48" / 22" x 64"

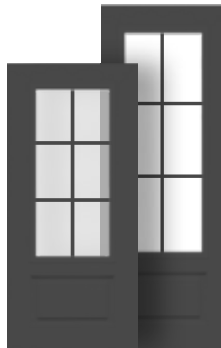

E760 / E775
22" x 48" / 22" x 64"

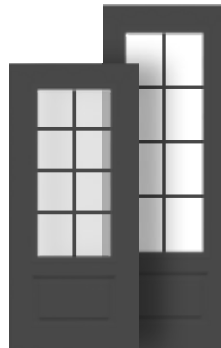

E677 / E777
22" x 48" / 22" x 64"

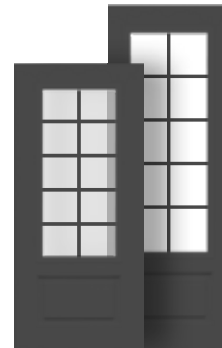

E679 / E779
22" x 48" / 22" x 64"

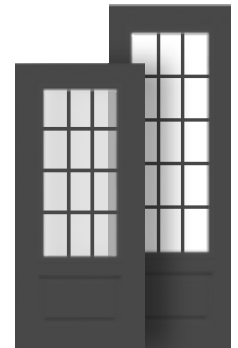

E681 / E781
22" x 48" / 22" x 64"

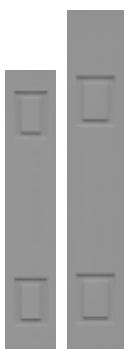

E702 / E708



E659* / E711
8" x 48" / 8" x 64"



E674 / E774
8" x 48" / 8" x 64"



E761* / E776
8" x 48" / 8" x 64"



E678* / E778
8" x 48" / 8" x 64"



E680* / E780
8" x 48" / 8" x 64"

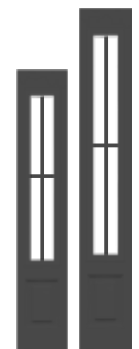

E682* / E782
8" x 48" / 8" x 64"

*Only available in 12" and 14"

SIZING

Heights

6'-8"

7'

8'

Widths

34" 36"

32" 34" 36"

32" 34" 36"

Flush Sidelites
Widths

12" 14"

12" 14"

12" 14"

EDGE SMOOTH

CONTEMPORARY

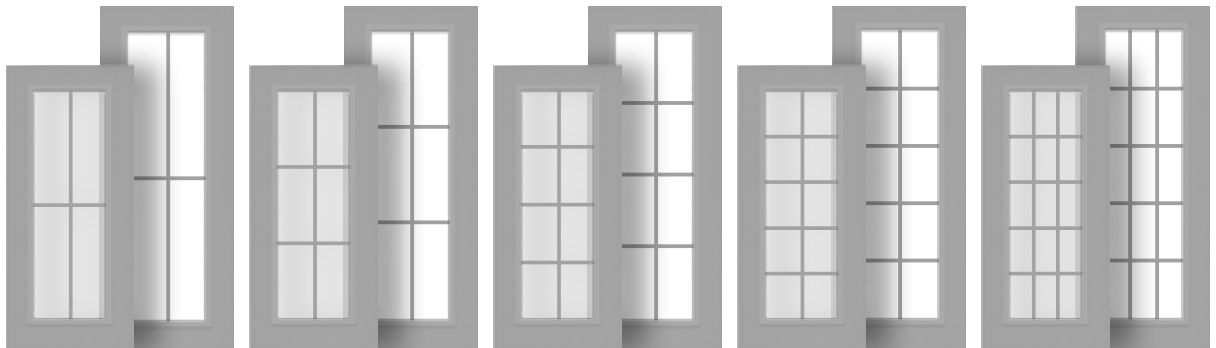

E793 / E791
22" x 64" / 22" x 80"

E795 / E783
22" x 64" / 22" x 80"

E797 / E785
22" x 64" / 22" x 80"

E770 / E787
22" x 64" / 22" x 80"

E772 / E790
22" x 64" / 22" x 80"

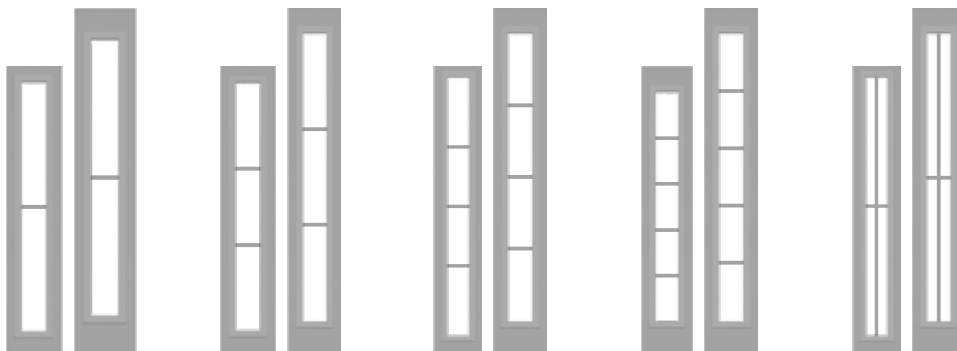

E794 / E792
8" x 64" / 8" x 80"

E796 / E784
8" x 64" / 8" x 80"

E798 / E786
8" x 64" / 8" x 80"

E771 / E788
8" x 64" / 8" x 80"

E799 / E789
8" x 64" / 8" x 80"

SIZING

Heights

6'-8"

7'

8'

Widths

32"

34"

36"

32"

34"

36"

32"

34"

36"

42"

Sidelites
Widths

12"

14"

16"

12"

14"

16"

12"

14"

16"

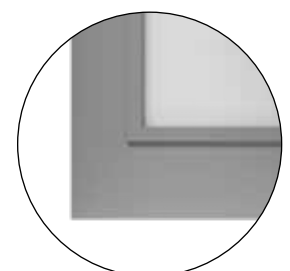

Contemporary Surround

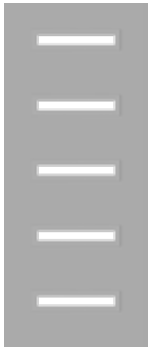

E719
22" x 3-1/2"

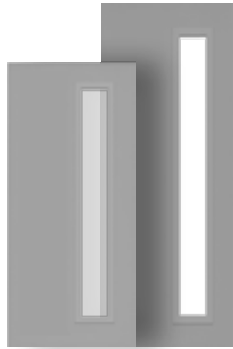

E726 / E725
8" x 64" / 8" x 80"
Also available in 8" x 42"

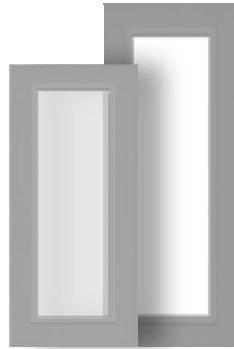

E717 / E724
22" x 64" / 22" x 80"

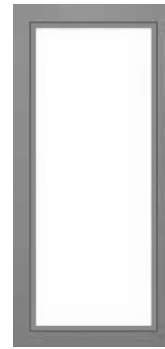

E728
28" x 80"
Only available in 8" x 42"



E701*



E712*
22" x 17"



E713*
22" x 17"



E714*
22" x 17"

* Not available in 8'

SIZING

Heights

6'-8"

7'

8'

Widths

32" 34" 36"

32" 34" 36"

32" 34" 36" 42"

2-1/4" slab thickness available for 8' doors without glass.
Only available for 36" x 8' and 42" x 8'

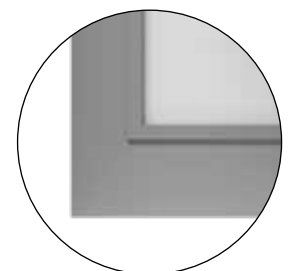

Contemporary Surround

EDGE SMOOTH

YourStyle™



E801-G



E762-G



E763-G



E764-G



E765-G



E766-G



E767-G



E768-G



E769-G



E850-G



E851-G

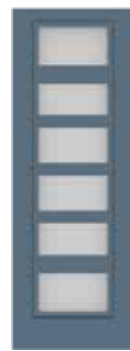

E852-G

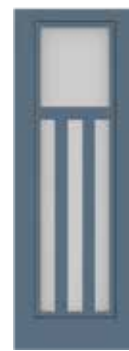

E853-G

SIZING

Heights

8'

Widths

34" 36" 42"

SDL bars available in 3-½" and 5-⅞" widths.

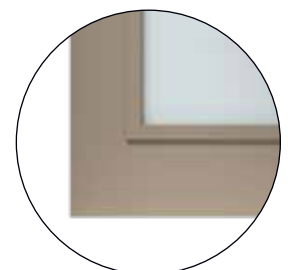

8' only available with contemporary surround

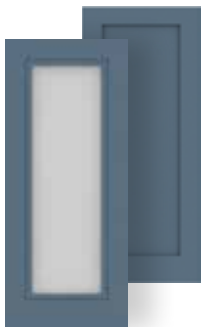

E800-G / E800



E822-G / E822



E823-G / E823



E824-G / E824



E825-G / E825

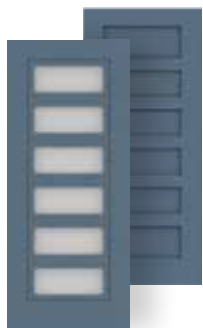

E826-G / E826



E827-G / E827



E828-G / E828



E829-G / E829



E830-G / E830



E831-G / E831



E832-G / E832

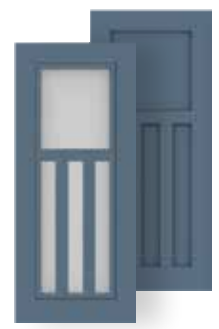

E833-G / E833

SIZING

Heights

- 6'-8"
- 7'

Widths

- 34"
- 36"

SDL bars available in 3-1/2" and 5-1/8" widths.



6'-8" and 7' available with flush surround

EDGE SMOOTH

CRAFTSMAN



E721



E722
23-3/4" x 15"



E723
23-3/4" x 15"



E729
23-3/4" x 15"



E730
23-3/4" x 15"

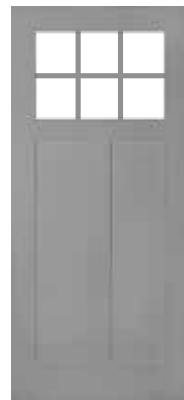

E731
23-3/4" x 15"

SIZING

Heights

6'-8" 7'

Widths

34" 36"

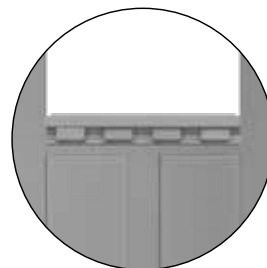

Integrated dentil shelf
option available

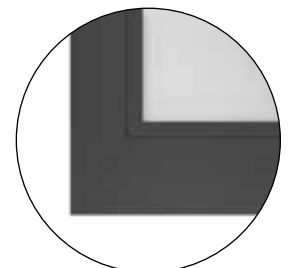

Flush Surround

EDGE SMOOTH

SHAKER



E738
22" x 36"



E740
22" x 36"



E742
22" x 36"



E744
22" x 36"



E739
8" x 36"



E741
8" x 36"



E743
8" x 36"



E745
8" x 36"

SIZING

Heights

6'-8"

7'

Widths

34"

36"

Sidelites
Widths

14"

16"



E748
22" x 48"



E750
22" x 48"



E652
22" x 48"



E654
22" x 48"



E656
22" x 48"



E749
8" x 48"



E751
8" x 48"



E653
8" x 48"



E655
8" x 48"



E657
8" x 48"

SIZING

Heights

8'

Widths

34"

36"

Sidelites
Widths

14"

16"

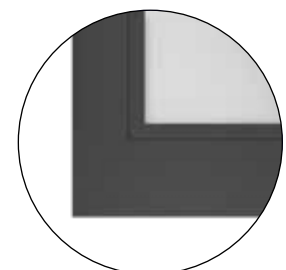

Flush Surround

EDGE SMOOTH

STAINLESS
INLAY



E601 / E608



E602 / E609



E603 / E610

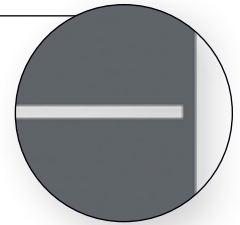

Engraving stops 3/4" from door edge for air and water protection



E604 / E611



E605 / E612



E606 / E613



E607 / E614

SIZING

Heights

6'-8" 8'

Widths

34" 36" 42'

Sidelites
Widths

12" 14" 16"

.175" skin thickness

2-3/4" slab thickness available for 8' doors without glass. Only available for 36" x 8'



Solid Slabs Only

EDGE SMOOTH

ENGRAVED



E703 / E705



E500 / E550

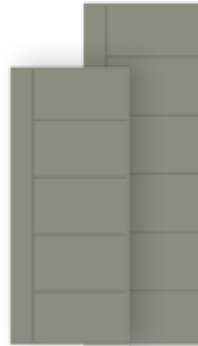

E501 / E551

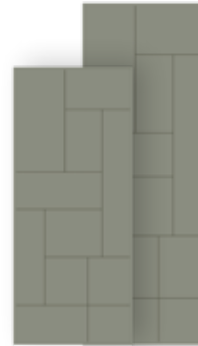

E528 / E553

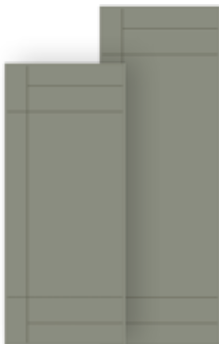

E536 / E552

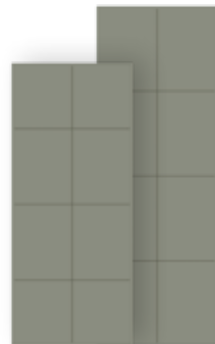

E900 / E950

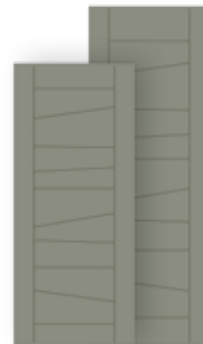

E901 / E951



E902 / E952

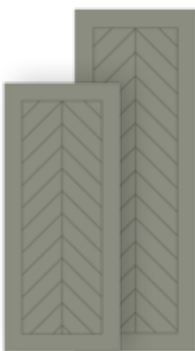

E903 / E953

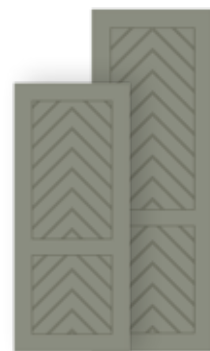

E904 / E954

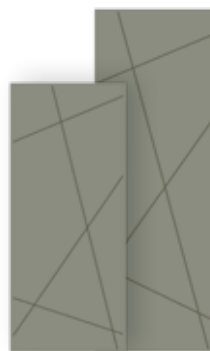

E905 / E955



E704 / E707

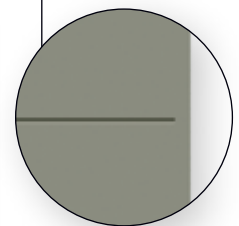

Engraving stops 3/4" from door edge for air and water protection

SIZING

Heights

6'-8"	8'
-------	----

Widths

34"	36"	34"	36"	42'
-----	-----	-----	-----	-----

Sidelites Widths

12"	14"	16"
-----	-----	-----

2-3/4" slab thickness available for 8' doors without glass.
Only available for 36" x 8'

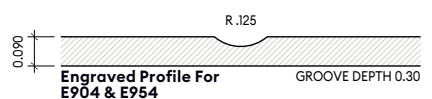
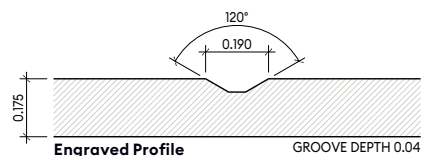

*Not engineering drawings, these are just for reference.

MAHOGANY

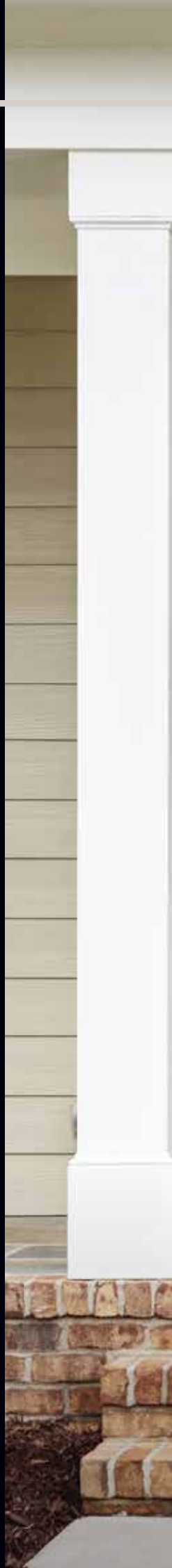





MAHOGANY

CLASSIC



M262



M252
22" x 11"



M253
22" x 11"



M267
14" x 37"



M264
22" x 48"



M266
22" x 48"



M271
22" x 48"



M254
22" x 64"



M278
22" x 64"



M256
22" x 64"



M257
22" x 64"



M-SL-48



M265
8" x 48"



M249
8" x 64"



M255
8" x 64"



M279
8" x 64"



M258
8" x 64"

SIZING

Heights

6'-8" 7'

Widths

32" 34" 36"

Sidelites
Widths

12" 14" 16"



Traditional Surround

MAHOGANY

CLASSIC



M268
22" x 48"



M270
22" x 48"



M280
22" x 48"



M273
22" x 48"



M274
22" x 48"



M269
8" x 48"



M272
8" x 48"



M276
8" x 48"



M281
8" x 48"



M275
8" x 48"

SIZING

Heights

6'-8" 7'

Widths

32" 34" 36"

Sidelites
Widths

12" 14" 16"



Traditional Surround



M247



M250
22" x 36"



M277
22" x 36"



M259
22" x 36"



M260
22" x 36"



M248
22" x 64"



M-SL-36



M251
8" x 36"



M261
8" x 36"



M249
8" x 64"

SIZING

Heights



Widths



Sidelites
Widths



Traditional Surround

OAK







OAK

CLASSIC



O292



O293
8" x 42"



O-SL-48



O279
8" x 64"



O273
8" x 64"



O285
8" x 64"



O274
8" x 64"



O275
8" x 64"



O323
8" x 64"



O276
8" x 64"



O288
8" x 64"

SIZING

Heights

6'-8"

7'

Widths

34"

36"

Sidelites
Widths

12"

14"

16"



Traditional Surround

OAK

CLASSIC



O277
 O282 22" x 11"
 O283 22" x 11"
 O280 22" x 36"
 O318 22" x 36"
 O289 22" x 36"
 O287 22" x 36"
 O290 22" x 36"



O278 22" x 64"
 O284 22" x 64"
 O322 22" x 64"
 O286 22" x 64"
 O272 22" x 64"



O-SL-36
 O281 8" x 36"
 O291 8" x 36"
 O279 8" x 64"
 O273 8" x 64"
 O285 8" x 64"
 O274 8" x 64"
 O275 8" x 64"
 O323 8" x 64"
 O276 8" x 64"
 O288 8" x 64"

SIZING

Heights

6'-8" 7'

Widths

32" 34" 36"

Sidelites
Widths

12" 14" 16"



Traditional Surround



O308



O309



O311
22" x 64"



O312
14" x 37"



O310
22" x 48"



O313
22" x 48"



O314
22" x 48"



O319
22" x 48"



O316
22" x 48"



O317
22" x 48"



O-SL-48



O279
8" x 64"



O295
8" x 48"



O300
8" x 48"



O303
8" x 48"



O315
8" x 48"



O320
8" x 48"



O307
8" x 48"

SIZING

Heights

6'-8" 7'

Widths

32" 34" 36"

Sidelites
Widths

12" 14" 16"



Traditional Surround



OAK

CLASSIC



O294



O296
22" x 48"



O297
22" x 48"



O298
14" x 37"



O299
22" x 48"



O301
22" x 48"



O321
22" x 48"



O304
22" x 48"



O305
22" x 48"



O-SL-48



O279
8" x 64"



O295
8" x 48"



O300
8" x 48"



O303
8" x 48"



O315
8" x 48"



O320
8" x 48"



O307
8" x 48"

SIZING

Heights

6'-8" 7'

Widths

32" 34" 36"

Sidelites Widths

12" 14" 16"



Traditional Surround

KNOTTY ALDER





KNOTTY ALDER RUSTIC



KA159



KA160



KA161
22" x 36"



KA181
22" x 36"



KA162
22" x 36"



KA163
22" x 36"



KA175
22" x 64"



KA179
22" x 64"



KA184
22" x 64"



KA176
22" x 64"



KA177
22" x 64"



KA-SLR



KA195
8" x 36"



KA182
8" x 36"



KA183
8" x 36"



KA164
8" x 64"



KA180
8" x 36"



KA185
8" x 36"



KA178
8" x 36"

SIZING

Heights

6'-8" 7'

Widths

32" 34" 36"

Sidelites
Widths

12" 14" 16"

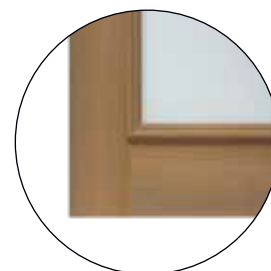

Traditional Surround



KA165



KA166



KA167
22" x 48"



KA170
22" x 48"



KA171
22" x 48"



KA172
22" x 48"



KA186
22" x 48"



KA173
22" x 48"



KA174
22" x 48"



KA-SLR



KA196
8" x 48"



KA187
8" x 48"



KA188
8" x 48"

SIZING

Heights

8'

Widths

32"

34"

36"

Sidelites
Widths

12"

14"

16"

2-1/4" slab thickness available for 8' doors without glass.
Only available for 36" x 8'



Traditional Surround

Dimension Matrix

GRAIN	MODEL NUMBER	COLLECTION	DESIGN	DOOR THICKNESS	PANEL NUMBER	CUTOUT OPTIONS	SDL OPTIONS
CHERRY	C499	Contemporary	Flush	1.75	Flush	✓	✓
	C500-C536	Contemporary	Engraved	1.75	Flush		
	C550-C553	Contemporary	Engraved	1.75	Flush		
	C900	Contemporary	Engraved	1.75	Flush		
	C950	Contemporary	Engraved	1.75	Flush		
	C901	Contemporary	Engraved	1.75	Flush		
	C951	Contemporary	Engraved	1.75	Flush		
	C902	Contemporary	Engraved	1.75	Flush		
	C952	Contemporary	Engraved	1.75	Flush		
	C903	Contemporary	Engraved	1.75	Flush		
	C953	Contemporary	Engraved	1.75	Flush		
	C904	Contemporary	Engraved	1.75	Flush		
	C954	Contemporary	Engraved	1.75	Flush		
	C905	Contemporary	Engraved	1.75	Flush		
	C955	Contemporary	Engraved	1.75	Flush		
	C601-C606	Contemporary	Stainless Inlay	1.75	Flush		
	C607	Contemporary	Stainless Inlay	1.75	Flush		
	C608-C613	Contemporary	Stainless Inlay	1.75	Flush		
	C614	Contemporary	Stainless Inlay	1.75	Flush		
	C200	Classic		1.75	6	✓	✓

All door panels are available in 2-1/4" thickness without door lites. For more information consult a Dealer or MASTERGRAIN representative.

All solid panel styles are also available in a 2-1/4" thickness without glass options. For any additional information talk to the MASTERGRAIN™ sales representative.

WIDTH	HEIGHT			MATCHING SIDELITES	SIDELITE WIDTHS				TESTING		
	6'-8"	7'	8'		10	12	14	16	NAFS	ENERGY STAR	HVHZ
32"	✓	✓	✓	C498	✓	✓	✓	✓	✓	✓	✓
34"	✓	✓	✓								✓
36"	✓	✓	✓								✓
42"	✓	✓	✓								✓
32"	✓			C498	✓	✓	✓	✓	✓	✓	✓
34"	✓										✓
36"	✓										✓
42"	✓										✓
32"			✓	C498	✓	✓	✓	✓	✓	✓	✓
34"			✓								✓
36"			✓								✓
42"			✓								✓
32"	✓			C498	✓	✓	✓	✓	✓	✓	✓
34"	✓										✓
36"	✓										✓
42"	✓										✓
32"			✓	C498	✓	✓	✓	✓	✓	✓	✓
34"			✓								✓
36"			✓								✓
42"			✓								✓
32"	✓			C498	✓	✓	✓	✓	✓	✓	✓
34"	✓										✓
36"	✓										✓
42"	✓										✓
32"			✓	C498	✓	✓	✓	✓	✓	✓	✓
34"			✓								✓
36"			✓								✓
42"			✓								✓
32"	✓			C498	✓	✓	✓	✓	✓	✓	✓
34"	✓										✓
36"	✓										✓
42"	✓										✓
32"			✓	C498	✓	✓	✓	✓	✓	✓	✓
34"			✓								✓
36"			✓								✓
42"			✓								✓
32"	✓			C498	✓	✓	✓	✓	✓	✓	✓
34"	✓										✓
36"	✓										✓
42"	✓										✓
32"			✓	C498	✓	✓	✓	✓	✓	✓	✓
34"			✓								✓
36"			✓								✓
42"			✓								✓
32"	✓			C498	✓	✓	✓	✓	✓	✓	✓
34"	✓										✓
36"	✓										✓
42"	✓										✓
32"			✓	C498	✓	✓	✓	✓	✓	✓	✓
34"			✓								✓
36"			✓								✓
42"			✓								✓
32"	✓	✓		C-SL-36		✓	✓	✓	✓	✓	✓
34"	✓	✓									✓
36"	✓	✓									✓
42"	✓	✓									✓

Dimension Matrix

GRAIN	MODEL NUMBER	COLLECTION	DESIGN	DOOR THICKNESS	PANEL NUMBER	CUTOUT OPTIONS	SDL OPTIONS
CHERRY	C215	Classic		1.75	8	✓	
	C220	Classic		1.75	3	✓	✓
	C233 C234	Classic		1.75	2	✓	✓
	C250	Classic		1.75	2	✓	✓
	C217 C218 C219	Classic		1.75	2	✓	✓
	C100 C101	Rustic		1.75	2	✓	✓
	C144 C145	Rustic		1.75	2	✓	✓
FIR	F800	YourStyle™		1.75	1	✓	✓
	F801	YourStyle™		1.75	1	✓	✓
	F822-F833	YourStyle™		1.75	1	✓	✓
	F862-F873	YourStyle™		1.75	1	✓	✓
	F300	Craftsman		1.75	3	✓	✓
	F350	Craftsman		1.75	3	✓	✓
EDGE SMOOTH	E700	Contemporary		1.75	2	✓	✓
	E706	Contemporary		1.75	2	✓	✓
	E701	Contemporary		1.75	3	✓	
	E800-E834	YourStyle™		1.75	3	✓	✓
	E721	Craftsman		1.75	3	✓	✓
	E601-E607	Contemporary	Stainless Inlay	1.75	Flush		
	E608-E614	Contemporary	Stainless Inlay	1.75	Flush		
	E703	Contemporary		1.75	Flush	✓	✓

All door panels are available in 2-1/4" thickness without door lites. For more information consult a Dealer or MASTERGRAIN representative.

All solid panel styles are also available in a 2-1/4" thickness without glass options. For any additional information talk to the MASTERGRAIN™ sales representative.

WIDTH	HEIGHT			MATCHING SIDELITES	SIDELITE WIDTHS				TESTING			
	6'-8"	7'	8'		10	12	14	16	NAFS	ENERGY STAR	HVHZ	
32"				C-SL-48							✓	
34"	✓	✓					✓	✓	✓	✓	✓	✓
36"	✓	✓								✓	✓	✓
42"												✓
32"	✓	✓		C-SL-48							✓	
34"	✓	✓					✓	✓	✓	✓	✓	✓
36"	✓	✓								✓	✓	✓
42"												✓
32"	✓	✓		C-SL-48							✓	
34"	✓	✓					✓	✓	✓	✓	✓	✓
36"	✓	✓								✓	✓	✓
42"												✓
32"			✓	C8-SL-64							✓	
34"			✓									✓
36"			✓									✓
42"												✓
32"				C8-SL-48							✓	
34"												✓
36"												✓
42"			✓									✓
32"	✓	✓		C-SLR							✓	
34"	✓	✓										✓
36"	✓	✓										✓
42"												✓
32"			✓	C-SLR							✓	
34"			✓									✓
36"			✓									✓
42"												✓
32"				F-316 F-317							✓	
34"	✓	✓										✓
36"	✓	✓										✓
42"												✓
32"				F381 F385							✓	
34"			✓									✓
36"			✓									✓
42"												✓
32"				F-316 F-317							✓	
34"	✓	✓										✓
36"	✓	✓										✓
42"												✓
32"				F381 F385							✓	
34"			✓									✓
36"			✓									✓
42"												✓
32"	✓	✓		F-316 F-317							✓	
34"	✓	✓										✓
36"	✓	✓										✓
42"												✓
32"				F381 F385							✓	
34"			✓									✓
36"			✓									✓
42"												✓
32"	✓	✓		E702							✓	
34"	✓	✓										✓
36"	✓	✓										✓
42"												✓
32"			✓	E708							✓	
34"			✓									✓
36"			✓									✓
42"												✓
32"	✓	✓									✓	
34"	✓	✓										✓
36"	✓	✓										✓
42"												✓
32"				E704							✓	
34"	✓	✓										✓
36"	✓	✓										✓
42"	✓	✓										✓
32"				E704							✓	
34"			✓									✓
36"			✓									✓
42"			✓									✓
32"				E704 E707							✓	
34"	✓	✓										✓
36"	✓	✓										✓
42"	✓	✓										✓

Dimension Matrix

GRAIN	MODEL NUMBER	COLLECTION	DESIGN	DOOR THICKNESS	PANEL NUMBER	CUTOUT OPTIONS	SDL OPTIONS
EDGE SMOOTH	E705	Contemporary		1.75	Flush	✓	✓
	E500-E501	Contemporary	Engraved	1.75	Flush	✓	✓
	E550-E551	Contemporary	Engraved	1.75	Flush	✓	✓
	E528	Contemporary	Engraved	1.75	Flush	✓	✓
	E553	Contemporary	Engraved	1.75	Flush	✓	✓
	E536	Contemporary	Engraved	1.75	Flush	✓	✓
	E552	Contemporary	Engraved	1.75	Flush	✓	✓
	E900-E903	Contemporary	Engraved	1.75	Flush		
	E950-E953	Contemporary	Engraved	1.75	Flush		
	E904	Contemporary	Engraved	1.75	2		
	E954	Contemporary	Engraved	1.75	2		
	E905	Contemporary	Engraved	1.75	Flush		
	E955	Contemporary	Engraved	1.75	Flush		
MAHOAGANY	M262	Classic		1.75	3	✓	✓
	M247	Classic		1.75	6	✓	✓
OAK	O292	Classic		1.75	8	✓	
	O277	Classic		1.75	6	✓	✓
	O308 O309	Classic		1.75	2	✓	✓
	O294	Classic		1.75	3	✓	✓
KNOTTY ALDER	KA159 KA160	Rustic		1.75	2	✓	✓
	KA165 KA166	Rustic		1.75	2	✓	✓

All door panels are available in 2-1/4" thickness without door lites. For more information consult a Dealer or MASTERGRAIN representative.

All solid panel styles are also available in a 2-1/4" thickness without glass options. For any additional information talk to the MASTERGRAIN™ sales representative.

WIDTH	HEIGHT			MATCHING SIDELITES	SIDELITE WIDTHS				TESTING			
	6'-8"	7'	8'		10	12	14	16	NAFS	ENERGY STAR	HVHZ	
32"				E704 E707							✓	
34"			✓				✓	✓	✓	✓	✓	✓
36"			✓									✓
42"			✓									✓
32"				E704 E707							✓	
34"	✓						✓	✓	✓	✓	✓	✓
36"	✓											✓
42"												✓
32"				E704 E707							✓	
34"			✓				✓	✓	✓	✓	✓	✓
36"			✓									✓
42"			✓									✓
32"				E704 E707							✓	
34"	✓	✓					✓	✓	✓	✓	✓	✓
36"	✓	✓										✓
42"												✓
32"				E704 E707							✓	
34"			✓				✓	✓	✓	✓	✓	✓
36"			✓									✓
42"			✓									✓
32"				E704 E707							✓	
34"	✓	✓					✓	✓	✓	✓	✓	✓
36"	✓	✓										✓
42"												✓
32"				E704 E707							✓	
34"			✓				✓	✓	✓	✓	✓	✓
36"			✓									✓
42"			✓									✓
32"				E704 E707							✓	
34"	✓	✓					✓	✓	✓	✓	✓	✓
36"	✓	✓										✓
42"												✓
32"				E704 E707							✓	
34"			✓				✓	✓	✓	✓	✓	✓
36"			✓									✓
42"			✓									✓
32"				M-SL-48							✓	
34"	✓	✓					✓	✓	✓	✓	✓	✓
36"	✓	✓										✓
42"												✓
32"				M-SL-36							✓	
34"	✓	✓					✓	✓	✓	✓	✓	✓
36"	✓	✓										✓
42"												✓
32"				O-SL-48							✓	
34"	✓	✓					✓	✓	✓	✓	✓	✓
36"	✓	✓										✓
42"												✓
32"				O-SL-36							✓	
34"	✓	✓					✓	✓	✓	✓	✓	✓
36"	✓	✓										✓
42"												✓
32"				O-SL-48							✓	
34"	✓	✓					✓	✓	✓	✓	✓	✓
36"	✓	✓										✓
42"												✓
32"				O-SL-48							✓	
34"	✓	✓					✓	✓	✓	✓	✓	✓
36"	✓	✓										✓
42"												✓
32"				KA-SLR							✓	
34"	✓	✓					✓	✓	✓	✓	✓	✓
36"	✓	✓										✓
42"												✓
32"			✓	KA-SLR							✓	
34"			✓				✓	✓	✓	✓	✓	✓
36"			✓									✓
42"												✓

MG™



Limited Lifetime Warranty.
Visit www.mastergrain.com for Details.



MASTERGRAIN Showroom
6260-13 Hwy 7, Woodbridge, ON L4H 4G3

MASTERGRAIN Manufacturing
16567 ON-12, Midland, ON L4R 4L1

1-800-782-0559

MASTERGRAIN™ reserves the right to make changes to product design, finishes and technology.
Doors depicted in this brochure may not be exactly as shown.



National Fenestration
Rating Council®

CERTIFIED

01-2023